

ARCH PROFILE

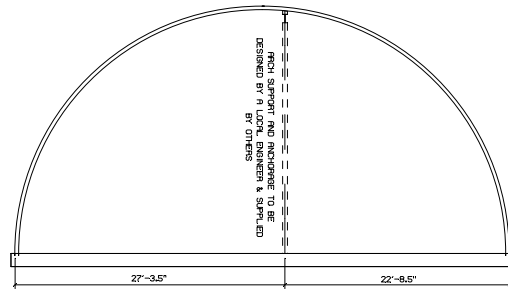

FRONT ELEVATION

REAR ENDWALL TO BE DESIGNED & SUPPLIED BY OTHERS

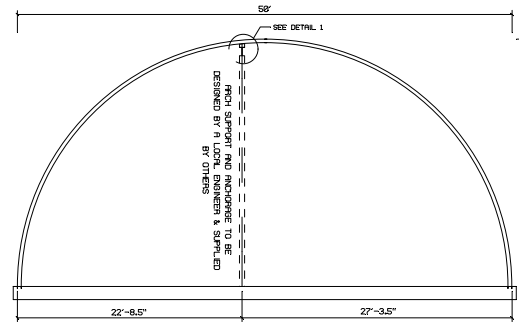

REAR ELEVATION

FRONT ENDWALL TO BE DESIGNED & SUPPLIED BY OTHERS

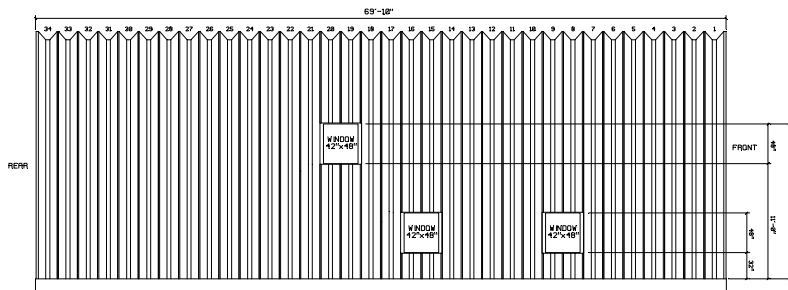

LEFT ELEVATION

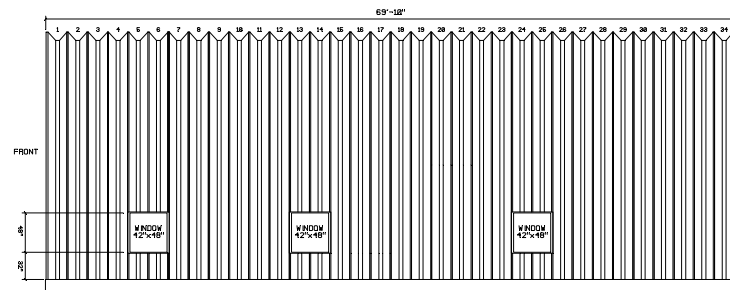

RIGHT ELEVATION

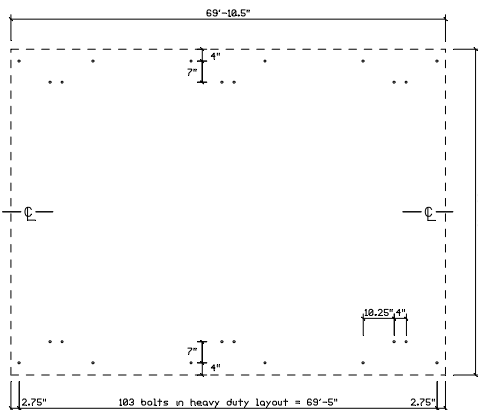

ANCHOR BOLT LAYOUT

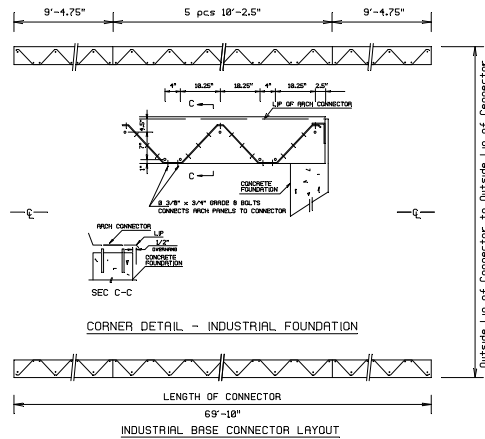

CORNER DETAIL - INDUSTRIAL FOUNDATION

INDUSTRIAL BASE CONNECTOR LAYOUT

UNFACTORED TYPICAL ARCH REACTIONS

LOAD TYPE	SUPPORT 1		SUPPORT 2		SUPPORT 3	
	HORIZ. REACTION (lbs/ft)	VERT. REACTION (lbs/ft)	HORIZ. REACTION (lbs/ft)	VERT. REACTION (lbs/ft)	HORIZ. REACTION (lbs/ft)	VERT. REACTION (lbs/ft)
DEAD LOAD	99	424	268	-69	462	
LIVE LOAD	148	461	667	-148	613	
SNOW LOAD	216	679	967	-226	821	
EXTERNAL WIND	-313	-228	-486	278	-281	
INTERNAL WIND PRESSURE	-4	-182	-2	4	-182	

FOUNDATION & ANCHORAGE MUST BE DESIGNED BY A LOCAL ENGINEER AND SUPPLIED BY OTHERS

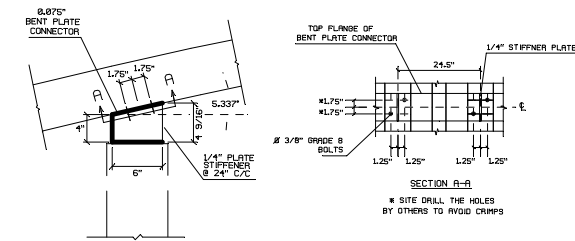

DETAIL 1

GENERAL NOTES

1. ALL MATERIAL AND WORKMANSHIP SHALL CONFORM WITH THE REQUIREMENTS OF THE LATEST REVISION OF THE INTERNATIONAL BUILDING CODE 2003. DESIGN ACCORDING TO AISI 9008-87, NORTH AMERICAN SPECIFICATION FOR THE DESIGN OF COLD-FORMED STEEL STRUCTURAL MEMBERS, AND WITH ANS/AISC 7-95.
2. NO LOADS OTHER THAN THOSE GIVEN UNDER "DESIGN DATA" BELOW SHALL BE IMPOSED ON THE "STRUCTURE".
3. SPECIFIC NOTES AND DETAILS SHOWN ON THE DRAWINGS SHALL TAKE PRECEDENCE OVER THE BUILDING MANUAL, SUPPLIED.
4. THE BUILDING, INCLUDING THE FOUNDATION, MUST BE CONSTRUCTED IN STRICT ACCORDANCE WITH THE DRAWING AND ERECTION INSTRUCTIONS. ANY DEVIATION, UNLESS APPROVED BY US IN WRITING, SHALL NULLIFY OUR CERTIFICATE AND SIGN. WE SHALL BE THE SOLE RESPONSIBILITY OF THE ERECTOR.
5. A PROFESSIONAL ENGINEER SHOULD BE RETAINED WHERE SITE INSPECTIONS ARE WARRANTED.
6. NO ARCH PANEL MAY BE CUT OR MODIFIED UNLESS IT IS TO ACCOMMODATE AN ACCESSORY PROVIDED BY THE MANUFACTURER IN ACCORDANCE WITH ITS INSTRUCTIONS AND/OR THIS DRAWING.
7. MINIMUM SEPARATION FROM THIS BUILDING TO ANY TALLER BUILDING MUST BE THE SMALLER OF 20 FEET AND 6 TIMES THE HEIGHT DIFFERENCE.

FOUNDATION NOTES

NOTE THE FOUNDATION AND THE BUILDING ANCHORAGE MUST BE DESIGNED BY A LOCAL ENGINEER BASED ON THE ARCH REACTIONS, BUILDING DIMENSIONS, ANCHOR BOLT SPECIFICATIONS, SITE CONDITIONS, & BUILDING CODE REQUIREMENTS

ARCH DATA

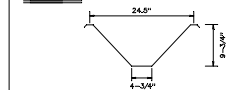

BOLTS ARE GRADE 2 OR ASTM A307
ROOF STEEL THICKNESS = 0.875 in.

ORALVALPINE SHEET STEEL
STRUCTURAL QUALITY ASTM SPECIFICATION A792-86a
S55 ALUMINUM-ZINC PLATED HOT DIP COATING
ASTM A792 GRADE S55
58 KSI MINIMUM YIELD
65 KSI MINIMUM TENSILE
HSS SECTIONS SHALL CONFORM TO:
ASTM A588 GRADE B (Fy = 48 ksi)
W SECTIONS SHALL CONFORM TO:
ASTM A992 GRADE 50 (Fy = 50 ksi)
OTHER SECTIONS SHALL CONFORM TO:
ASTM A36 (Fy = 36 ksi)

ARCH DESIGN DATA IN ACCORDANCE WITH ANS/AISC 7-95
ROOF LIVE LOAD (PSF) = 50
PG GROUND SNOW LOAD (PSF) = 60
CAL EXPOSURE FACTOR = 1.0
CH THERMAL FACTOR = 1.0
IMPORTANCE FACTOR (SNOW) = 1.0
CATEGORY II BUILDING
POINT COMPONENT WIND PRESSURE (PSF) = +/- 23
V : BASIC WIND SPEED (MPH) = 110
KTS VELOCITY PRESSURE EXPOSURE = 0.85
IMPORTANCE FACTOR (WIND) = 1.0
WIND EXPOSURE CATEGORY = C
SEISMIC DESIGN CATEGORY = B
COLLATERAL LOADS (PSF) = 9

LEGAL NOTE

This drawing is the property of Future Steel Buildings Int. Corp. Any duplication of this drawing in whole or in part is strictly forbidden. Anyone doing so will be prosecuted under the full extent of the law.

REVISIONS:
R1 - REV 5 2015 - REVISED - R.S.
R2 - JUNE 18 2015 - REVISED - R.S.

SteelMaster Buildings	
73 Ward Rd., Brantford, Ontario, Canada, L6R 6R6, Phone (519) 750-8888	
SCALE:	APPROVED BY: R.S.
DATE: May 04, 2015	CHECKED BY: R.S.
PROJECT:	TIMOTHY HORNE & PATSY VERHOEVEN
COMD, CO	
MODEL: XQ50-25	81-46887 R2
DWG:	DRAWING 1.1

ENGINEER'S SEAL

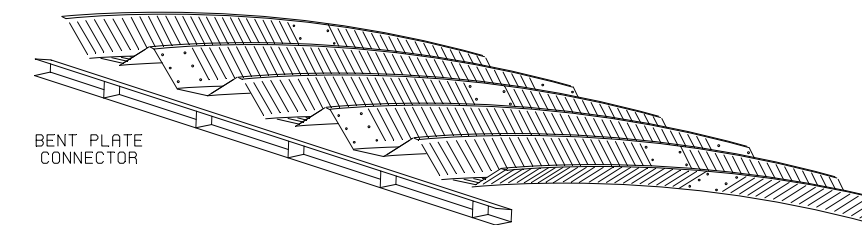
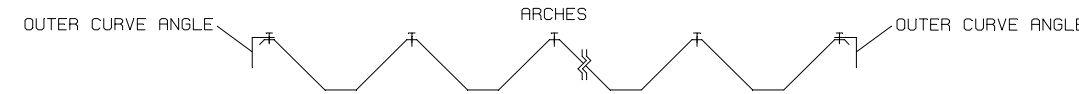
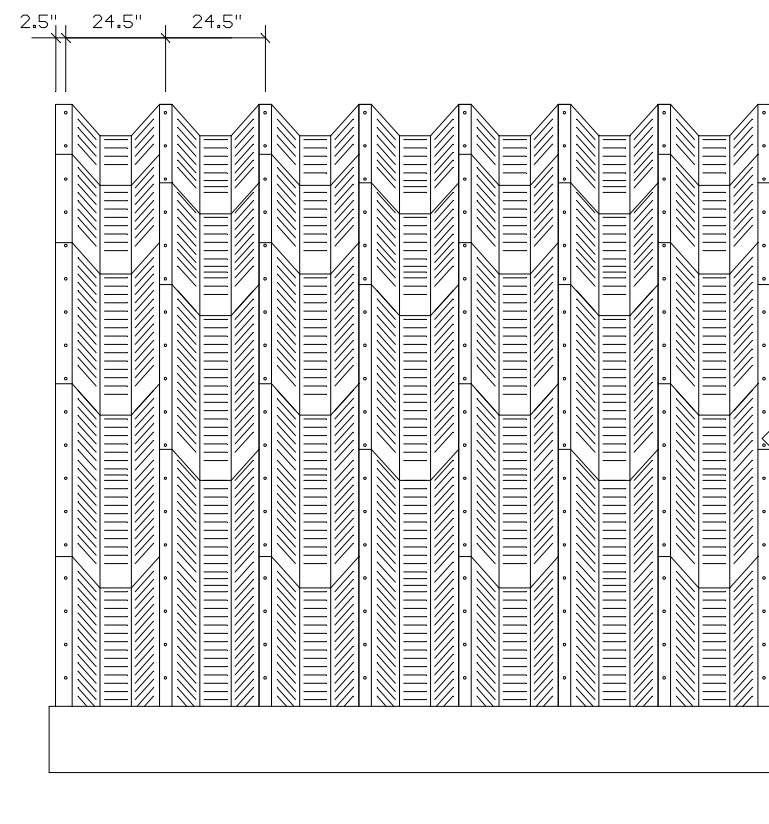
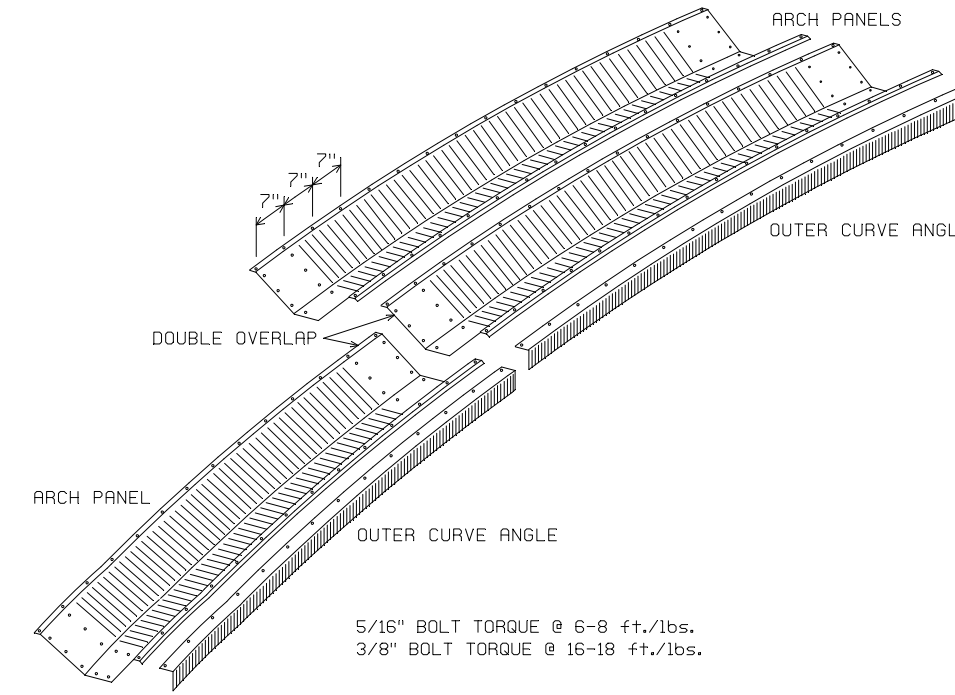
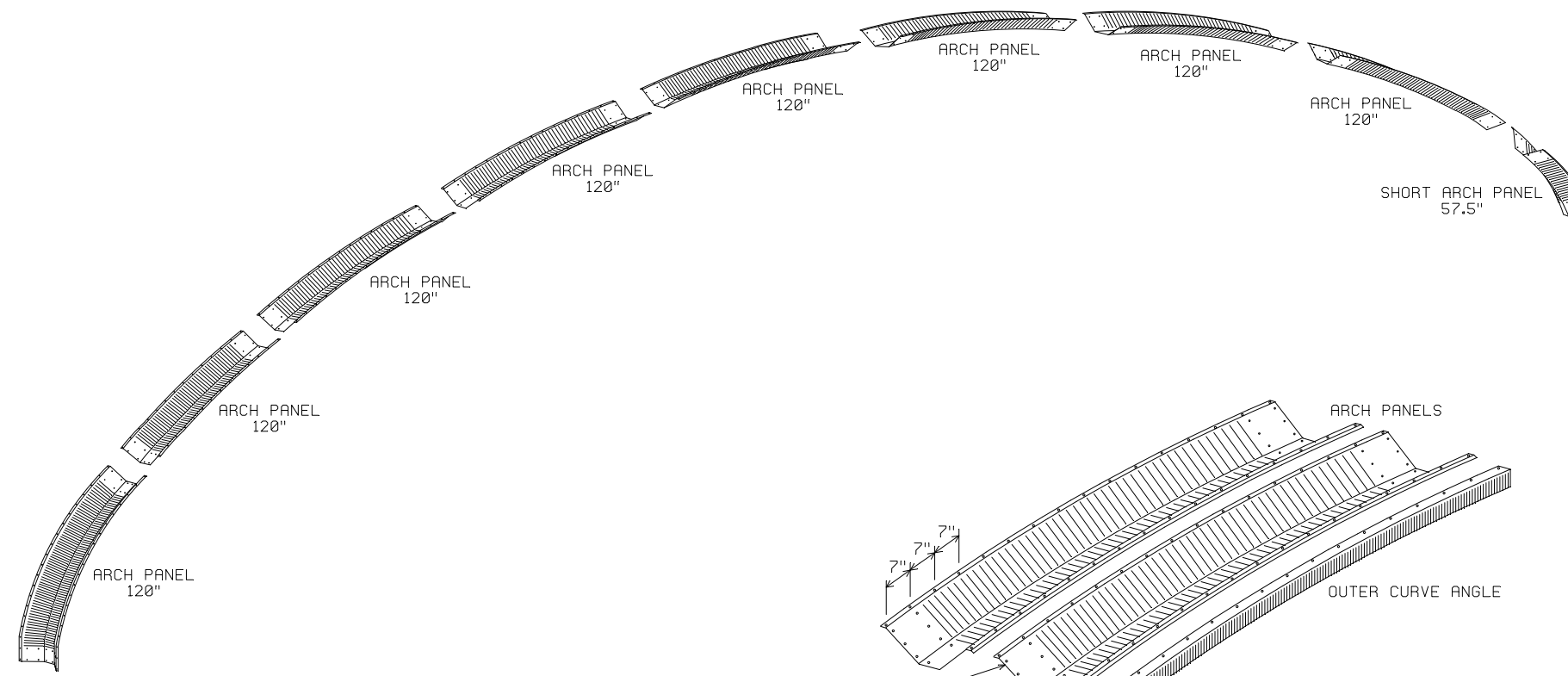
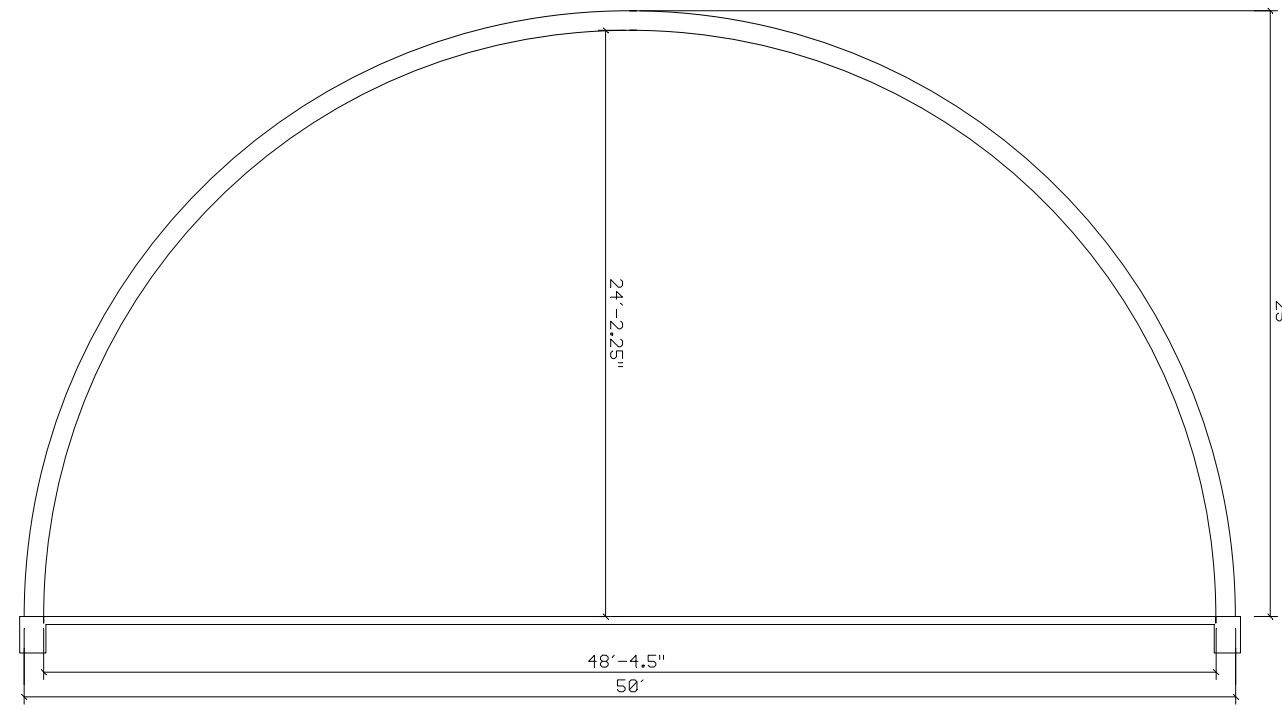

NOTES: BOLT-HOLES FOR BENT PLATE CONNECTOR TO ARCH PANEL CONNECTION DRILLED ON-SITE TO AVOID PANEL CAMPS (SEE DRAWING I.1 SECTION A-A).
 Ø3/8" x 3/4" BOLTS CONNECT ARCH PANELS TO BENT PLATE CONNECTOR.
 BENT PLATE CONNECTOR TO ARCH SUPPORT ATTACHMENT TO BE DESIGNED AND SUPPLIED BY OTHERS.

GENERAL NOTES

1. ALL MATERIAL AND WORKMANSHIP SHALL CONFORM WITH THE REQUIREMENTS OF THE LATEST REVISION OF THE INTERNATIONAL BUILDING CODE 2009. DESIGN ACCORDING TO AISI S100-07, NORTH AMERICAN SPECIFICATION FOR THE DESIGN OF COLD-FORMED STEEL STRUCTURAL MEMBERS, AND WITH ANSI/ASCE 7-05.
2. NO LOADS OTHER THAN THOSE GIVEN UNDER "DESIGN DATA" BELOW SHALL BE IMPOSED ON THE "STRUCTURE".
3. SPECIFIC NOTES AND DETAILS SHOWN ON THE DRAWINGS SHALL TAKE PRECEDENCE OVER THE BUILDING MANUAL SUPPLIED.
4. THE BUILDING, INCLUDING THE FOUNDATION, MUST BE CONSTRUCTED IN STRICT ACCORDANCE WITH THE DRAWING AND ERECTION INSTRUCTIONS. ANY DEVIATION, UNLESS APPROVED BY US IN WRITING, SHALL NULLIFY OUR CERTIFICATE AND SEAL AND SHALL BE THE SOLE RESPONSIBILITY OF THE ERECTOR.
5. A PROFESSIONAL ENGINEER SHOULD BE RETAINED WHERE SITE INSPECTIONS ARE WARRANTED.
6. NO ARCH PANEL MAY BE CUT OR MODIFIED UNLESS IT IS TO ACCOMMODATE AN ACCESSORY PROVIDED BY THE MANUFACTURER IN ACCORDANCE WITH ITS INSTRUCTIONS AND/OR THIS DRAWING.
7. MINIMUM SEPARATION FROM THIS BUILDING TO ANY TALLER BUILDING MUST BE THE SMALLER OF 20 FEET AND 6 TIMES THE HEIGHT DIFFERENCE.

FOUNDATION NOTES

NOTE: THE FOUNDATION AND THE BUILDING ANCHORAGE MUST BE DESIGNED BY A LOCAL ENGINEER BASED ON THE ARCH REACTIONS, BUILDING DIMENSIONS, ANCHOR BOLT SPECIFICATIONS, SITE CONDITIONS, & BUILDING CODE REQUIREMENTS

ARCH DATA

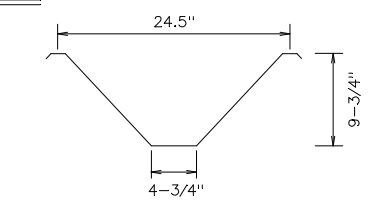

BOLTS: SAE GRADE 2 OR ASTM A307
 ROOF STEEL THICKNESS = 0.075 in.

GALVALUME SHEET STEEL
 STRUCTURAL QUALITY ASTM SPECIFICATION A792-06a
 55% ALUMINUM-ZINC ALLOY (HOT DIP COATING)
 ASTM A792 GRADE 50A
 50 KSI MINIMUM YIELD
 65 KSI MINIMUM TENSILE
 HSS SECTIONS SHALL CONFORM TO:
 ASTM A500 GRADE B (F_y = 46 ksi)
 W SECTIONS SHALL CONFORM TO:
 ASTM A992 GRADE 50 (F_y = 50 ksi)
 OTHER SECTIONS SHALL CONFORM TO:
 ASTM A36 (F_y = 36 ksi)

ARCH DESIGN DATA IN ACCORDANCE WITH ANSI/ASCE 7-05:

ROOF LIVE LOAD (PSF) = 50
 P_g: GROUND SNOW LOAD (PSF) = 60
 C_e: EXPOSURE FACTOR = 1.0
 C_t: THERMAL FACTOR = 1.0
 IMPORTANCE FACTOR (SNOW) = 1.0
 CATEGORY II BUILDING
 P_{net}: COMPONENT WIND PRESSURE (PSF) = +/- 23
 V : BASIC WIND SPEED (MPH) = 110
 K_z: VELOCITY PRESSURE EXPOSURE = 0.85
 IMPORTANCE FACTOR (WIND) = 1.0
 WIND EXPOSURE CATEGORY = C
 SEISMIC DESIGN CATEGORY = B
 COLLATERAL LOADS (PSF) = 9

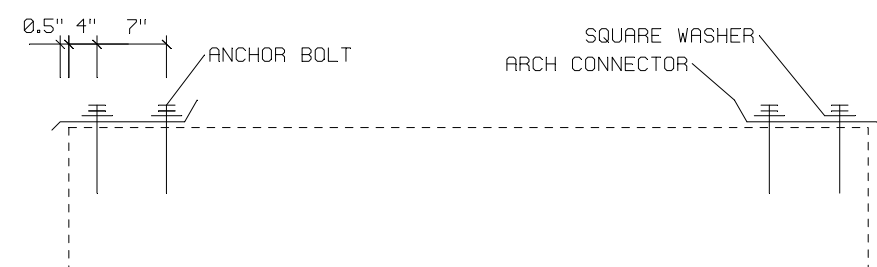
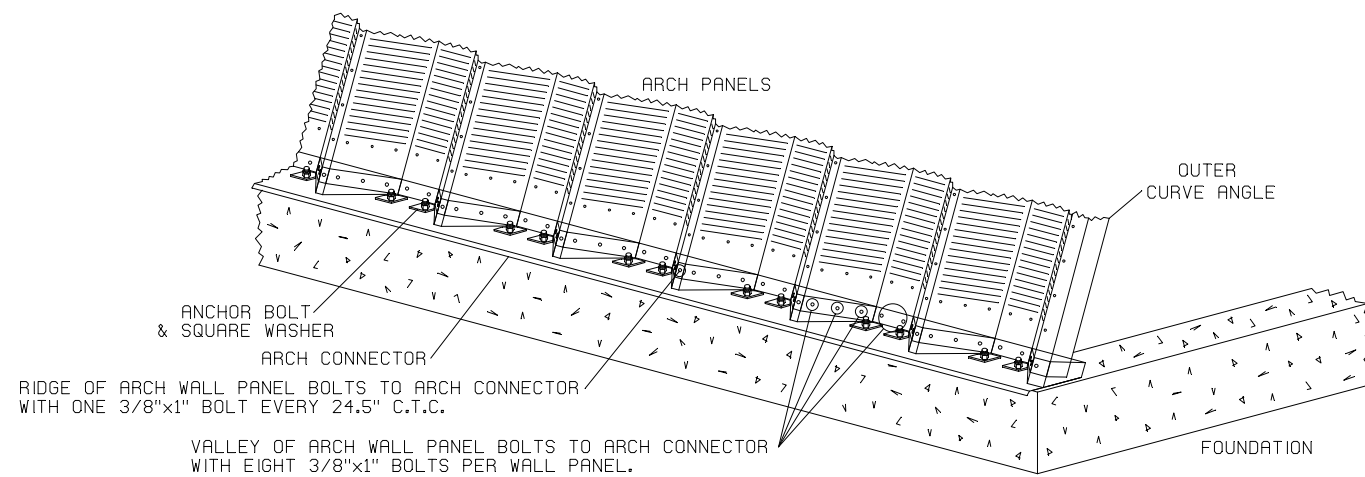

FOUNDATION END VIEW
 FOUNDATION WIDTH = ARCH WIDTH + 4.5"



FOUNDATION SIDE VIEW
 FOUNDATION LENGTH = # OF ARCHES x 24.5" + 5.5"

NOTE: REFER TO DRAWING I.1 FOR ANCHOR BOLT LAYOUT.
 FOUNDATION DESIGNED AND SUPPLIED BY OTHERS.

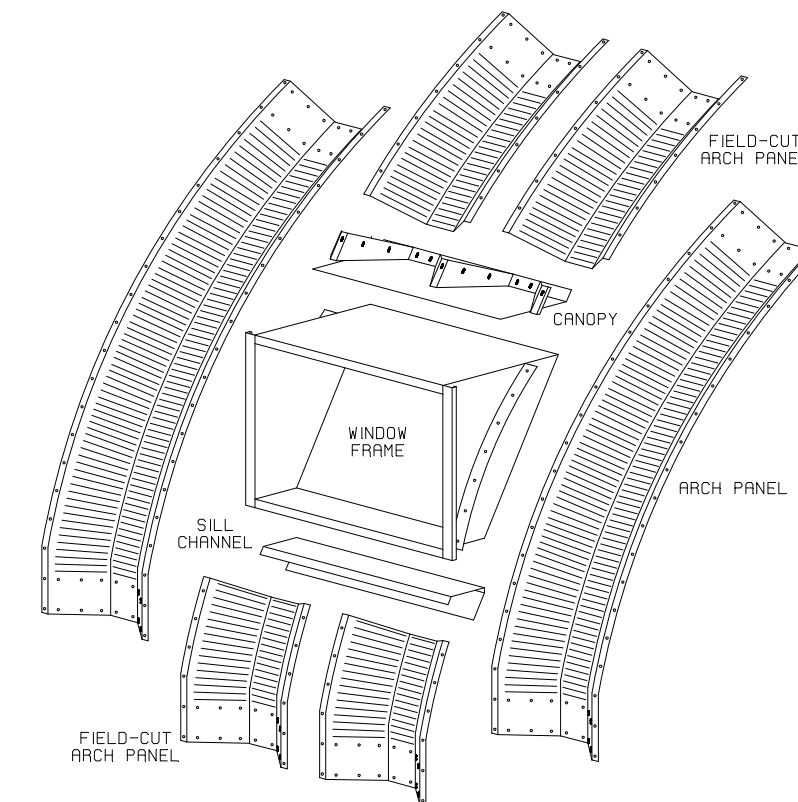
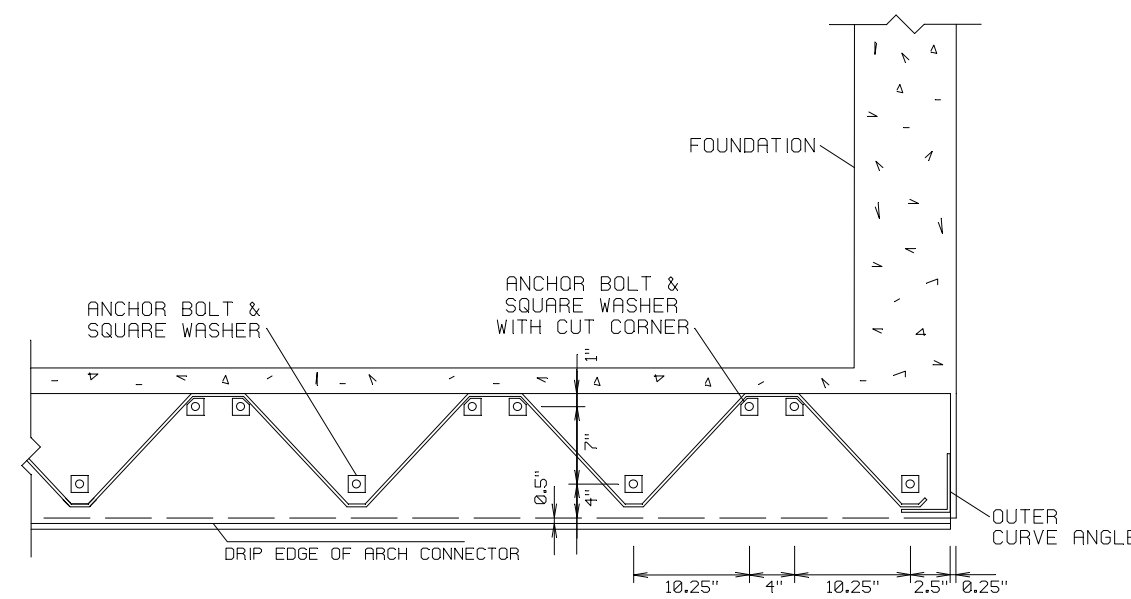

NOTES: SIDE WINDOW FRAMES INSTALLED AFTER ERECTION OF ALL ARCHES IS COMPLETE.
 ARCH PANELS FIELD-CUT TO FIT WINDOW FRAMES SET AT LOCATION AND SILL HEIGHT SPEC'D ON DRAWING I.1.

LEGAL NOTE

This drawing is the property of Future Steel Buildings Int'l. Corp. Any duplication of this drawing in whole or in part is strictly forbidden. Anyone doing so will be prosecuted under the full extent of the law.

REVISIONS:

SteelMaster Buildings	
73 Ward Rd., Brampton, Ontario, Canada, L6S 6R6, Phone: (905) 790-8500	
N.T.S.	P.B.
SCALE:	APPROVED BY:
June 3, 2015	K.P.
DATE:	CHECKED BY:
PROJECT:	TIMOTHY HORNE & PATSY VERHOEVEN
	COMO, CO
MODEL:	XQ50-25
DWG:	81-46887 R DRAWING 1.2

ENGINEER'S SEAL